

# HeadsQuarter

Living  
Workspaces

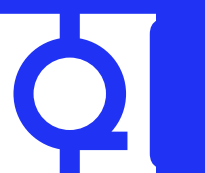

# About

## What sets us apart.

HeadsQuarter creates a working environment where well-being and productivity are enhanced by exceptional space and uncomplicated service.

### Top Downtown Locations

With HeadsQuarter you are always at the best location and have access to meeting and event rooms for various occasions.

### Inspiring Ambience

Our event rooms provide an inspiring atmosphere that captivates your guests and creates the perfect environment for any occasion.

### Versatile Room Layouts

Flexibility is key. Our spaces can be customized to meet your needs, whether it's for meetings, workshops, or larger events—the room setup adapts to your requirements.

### State-of-the-Art Equipment

Our venues are equipped with the latest technology to ensure your event runs smoothly—from presentation tools to high-quality audio and video equipment.

Even personal IT support is included.



Event and Meeting Room Space.



# Our Spaces

## Talacker 41

8001 Zürich

- 1500m<sup>2</sup> with 200+workstations
- Two floors
- 6 Meetingrooms
- Design Event room
- In house restaurants
- View on the Botanical - Garden
- Parking garage
- Walking distance from main station - 8 min

## Uraniastrasse 31

8001 Zürich

- 1800m with 220+ workstations
- Two floors
- 8 Meetingrooms
- Large event room
- Recording studio
- Event bar
- Walking distance from main station - 6 min

## Ernst-Nobs-Platz 1

8004 Zürich

- 2000m<sup>2</sup> with 200+workstations
- Two floors
- 4 Meetingrooms
- In-house bistro/bar
- Event space for 150+ guests
- Parking garage
- Walking distance from main station - 10 min

## Beethovenstrasse 48

8002 Zürich

- 2400m<sup>2</sup> with 260+ workstations
- Three floors
- 6 Meetingrooms
- Large event room
- Sports center with gym
- Parking places
- Distance from main station by tram - 7 min

## Coming soon:

## Stockerstrasse 33

8002 Zürich

- 4100m<sup>2</sup> with 550+ workstations
- Five floors
- Large event room
- Rooftop bar
- Recording Studio
- Distance from main station by tram - 7 min

Five workspaces within walking distance.

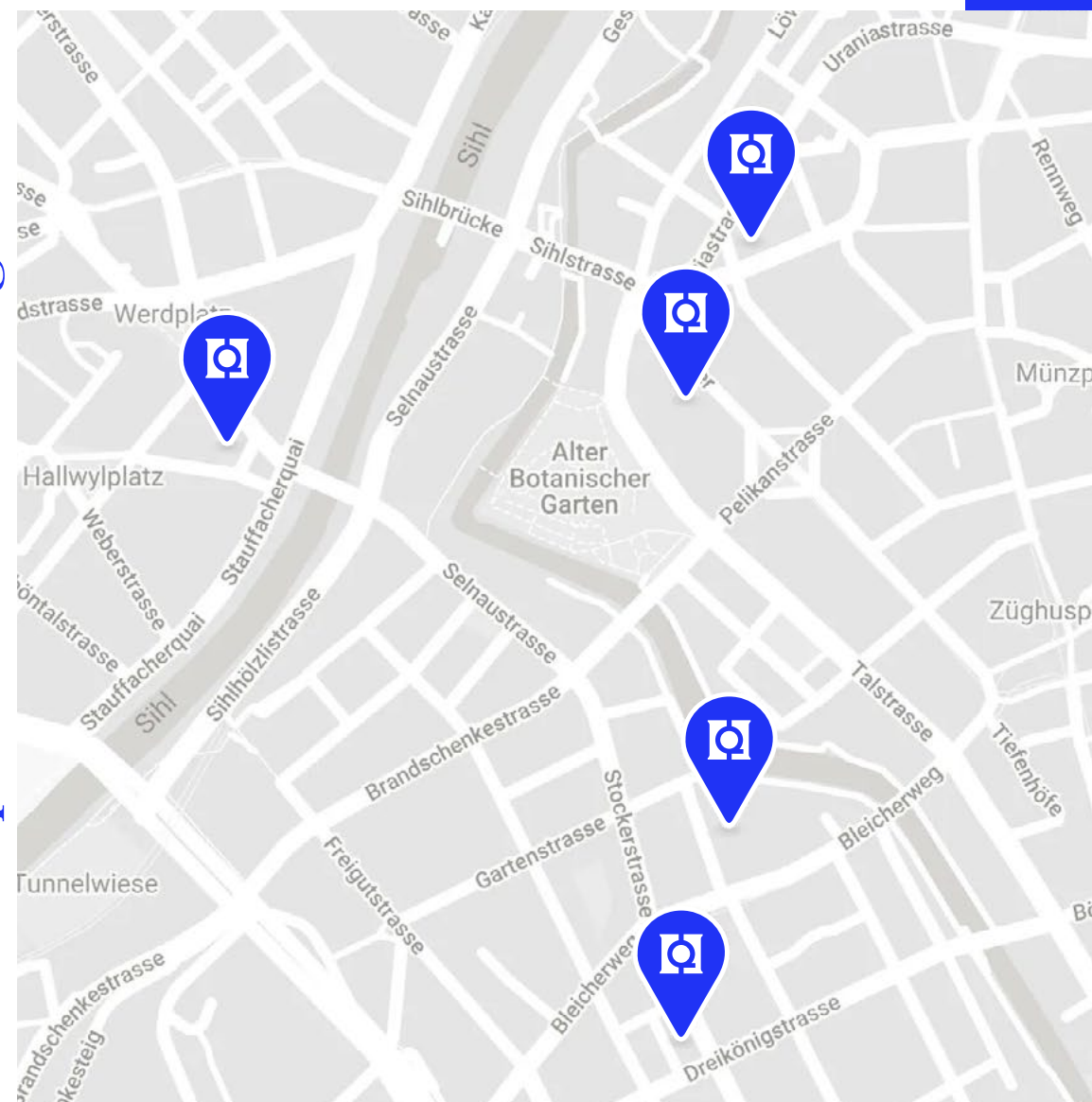

# They trust us

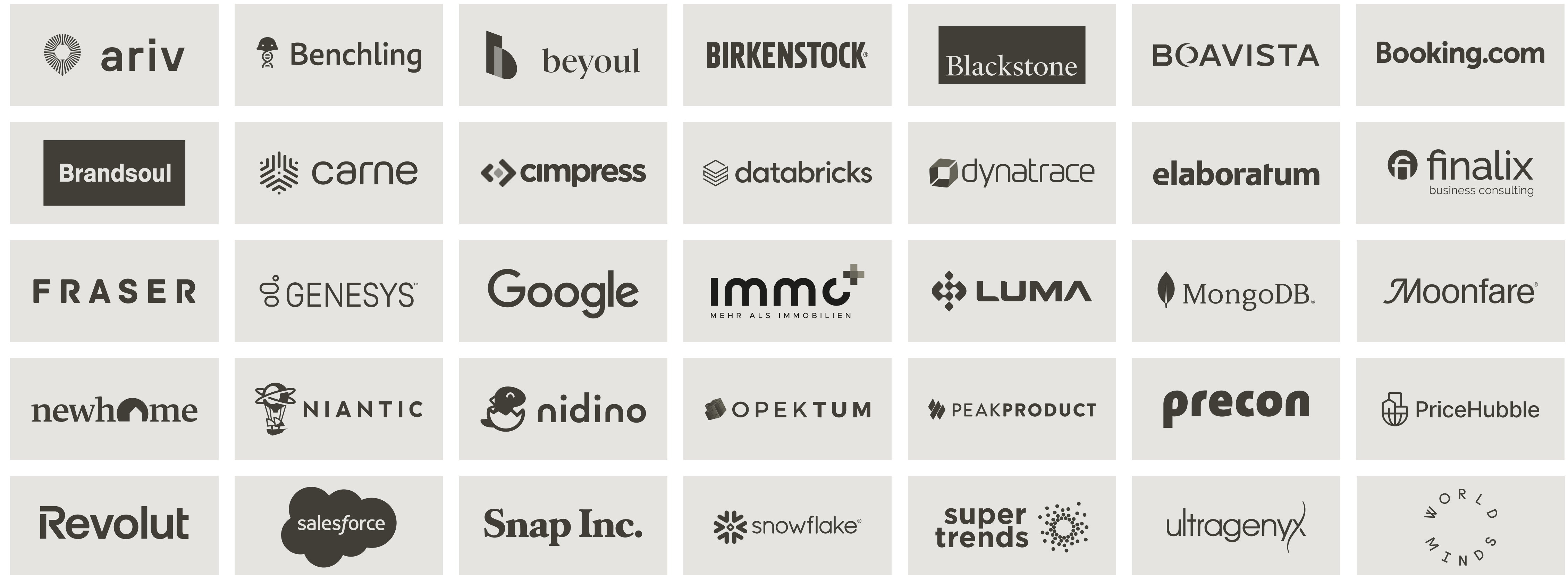

# Community



**These companies  
have trusted us**

- AMAN
- Apple
- Burger King
- Ernst & Young
- EWZ
- Fachstelle Kultur Stadt Zürich
- Globus
- Hero AG
- Hotellerie Schweiz Hirslanden
- IWC Schaffhausen
- Smart
- ON
- Real Time Society
- Rituals
- Soho House
- Swiss Life
- Zürich Design Week

Event and Meeting Room Space.



# Meeting Lounge | Our Lounge for 4 People



Helike & Thebe Library

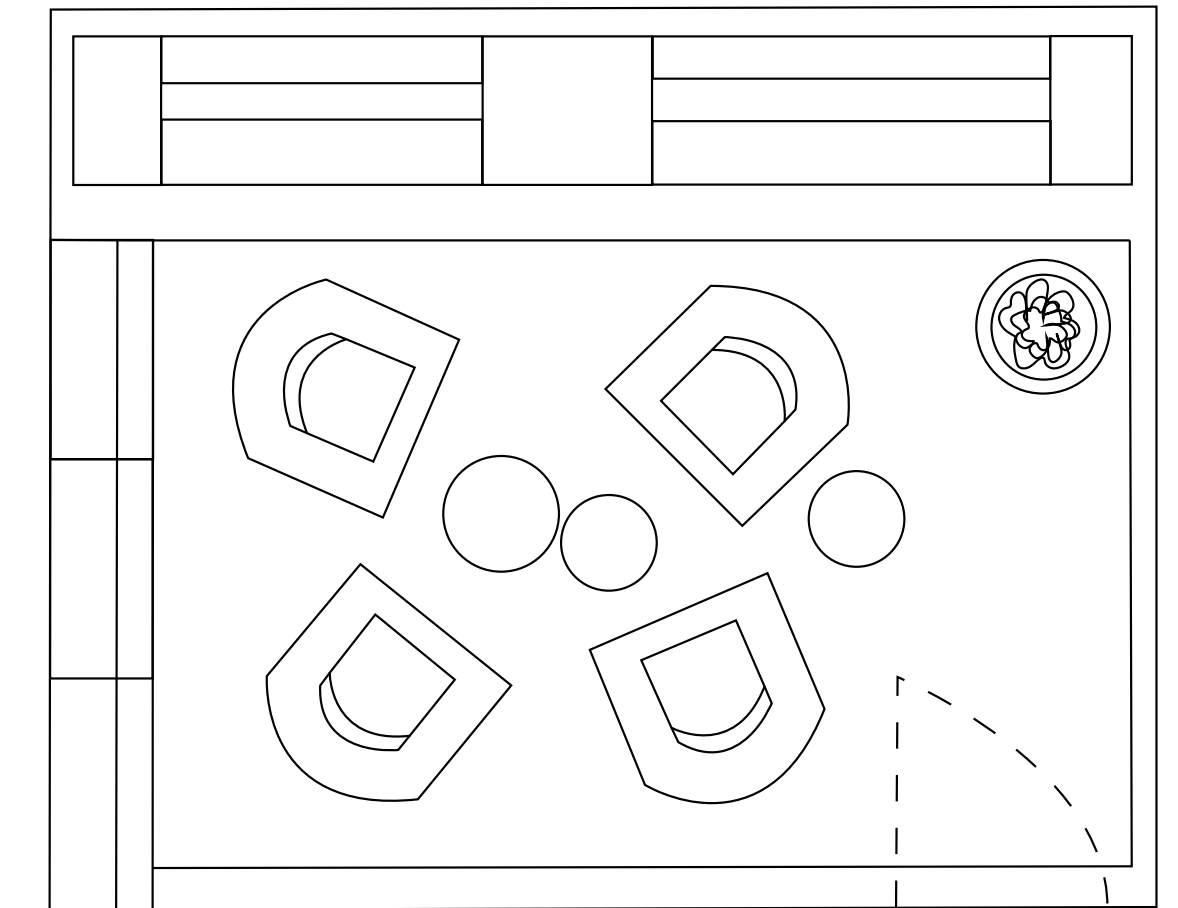

## Capacity & Equipment

- Up to 4 People
- Library
- Bluetooth Speaker

Well suited for long conversations, discussions and brainstorming.

**Price: 80 CHF/H**



# Recording Room | Our Room for 2 People



Studio

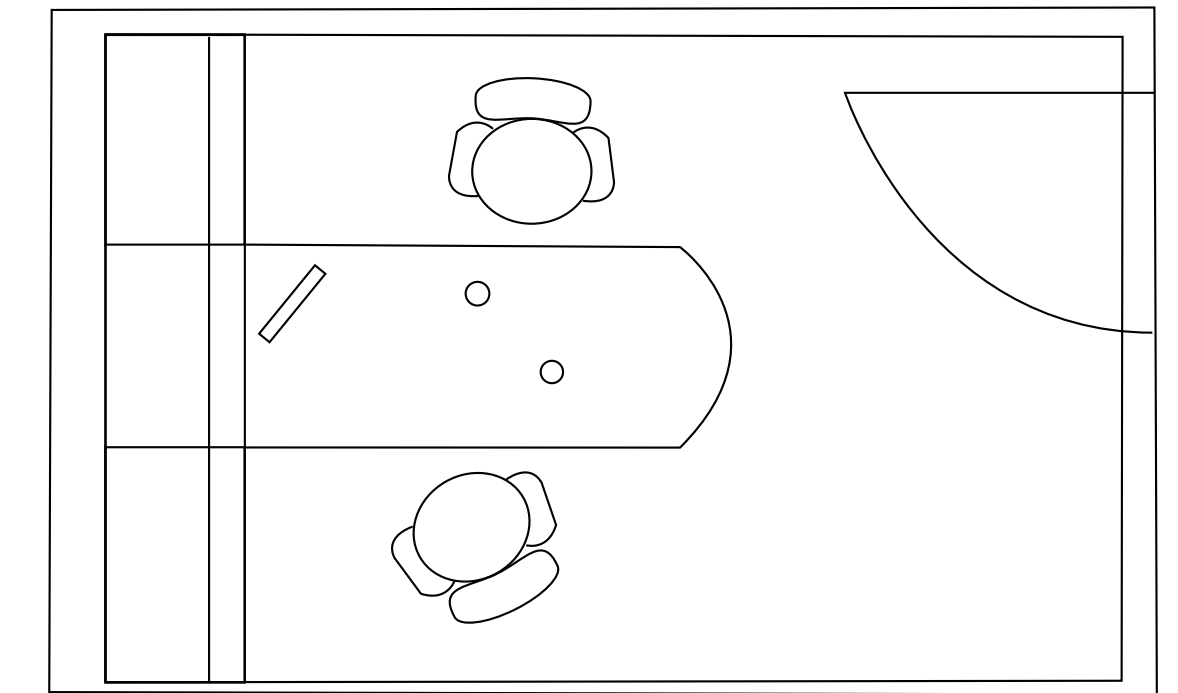

## Capacity & Equipment

- Up to 2 People
- Apple iMac 24", M1, 16 GB, 512 GB, SSD
- RØDE DS1 Mikrophone Stand
- RØDE RODECaster Pro
- Beyer M88 Mikrophone
- Beyerdynamic DT 990Pro Headphones
- Sony ZV-E10 Camera

More Details on request.

**Price: 110 CHF/H**  
With It Support + 150 CHF/H



# Meeting Room | Our Room for 3 People



Narvi

## Capacity & Equipment

- Up to 3 People
- LG Screen 4K, LED, 2022, 65
- Logitech Rally Bar Conference Cam & Speakers
- Whiteboard
- Office Material Trolley
- USB-C Connector
- HDMI - Connection

**Price: 60 CHF/H**





# Meeting Room | Our Rooms for 6 People

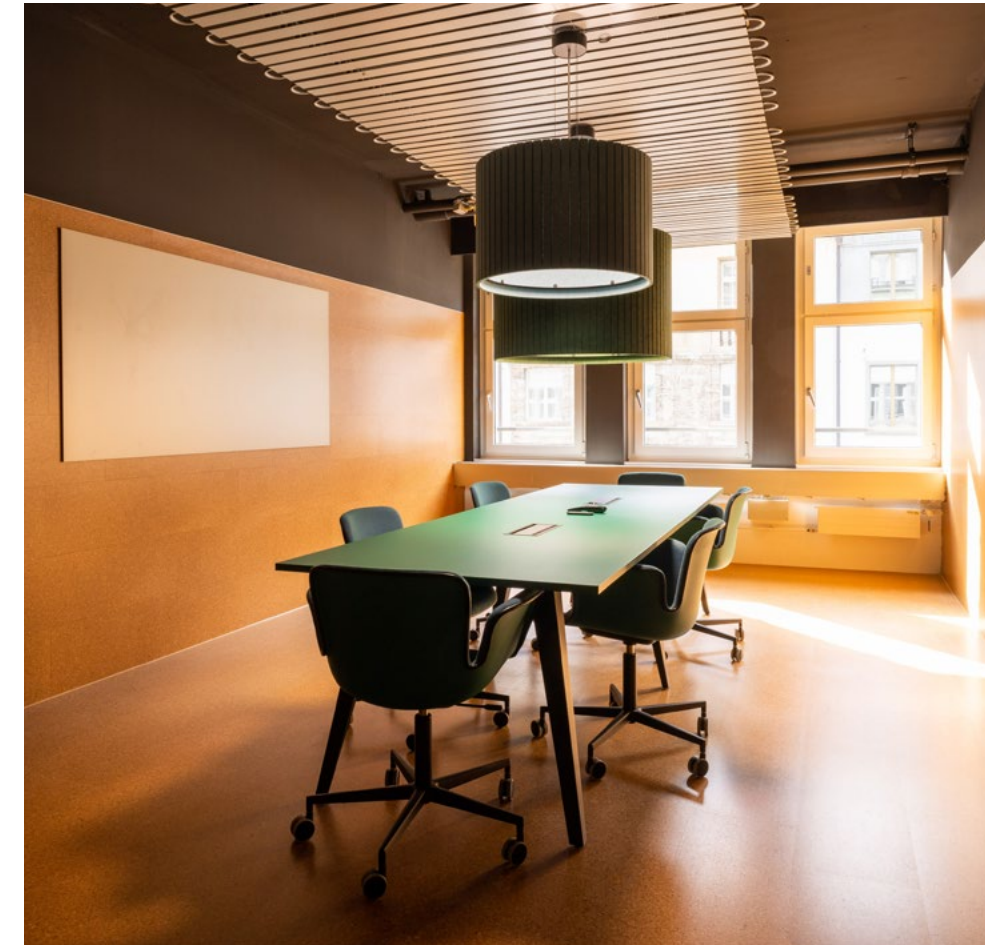
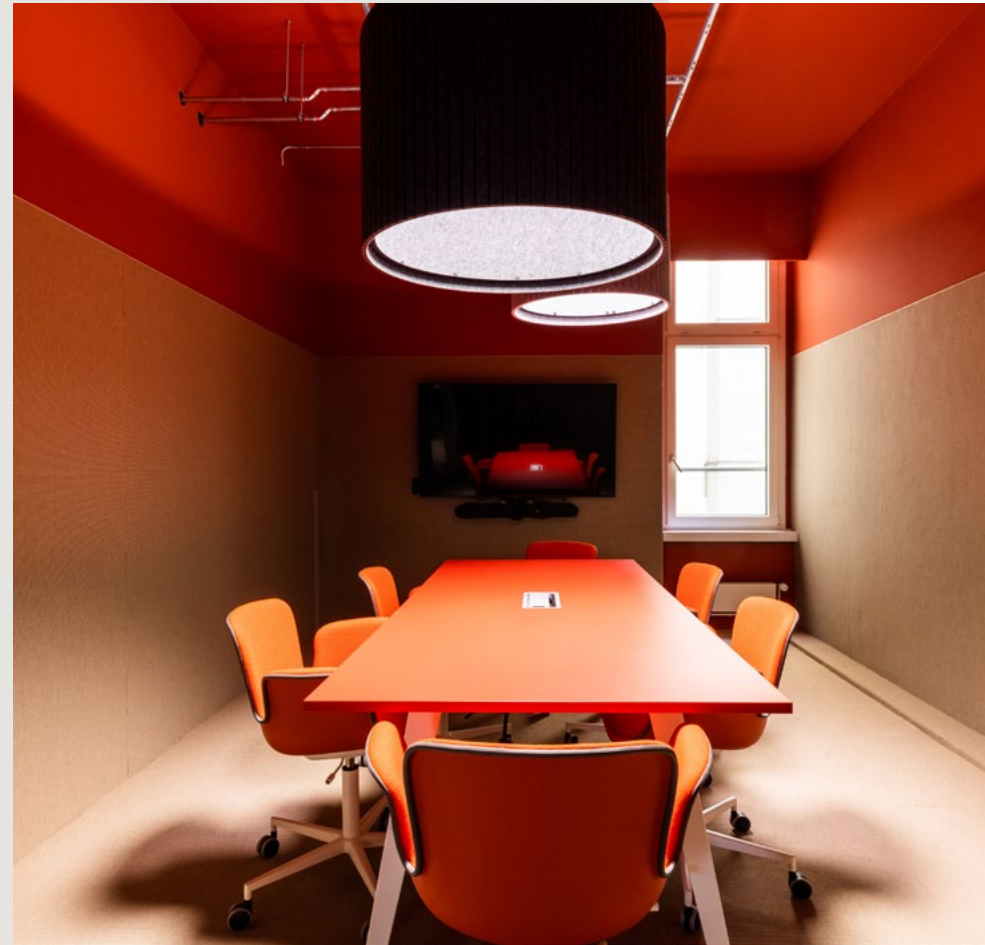

Metis, Amalthea, Cyllene, Elara, Daphnis & Kore

## Capacity & Equipment

- Up to 6 People
- LG Screen 4K, LED, 2022, 65
- Logitech Rally Bar Conference Cam & Speakers
- Whiteboard
- Office Material Trolley
- USB-C Connector
- HDMI - Connection

**Price: 90 CHF/H**



# Meeting Room | Our Rooms for 8 People



Rhea, Leda & Dione

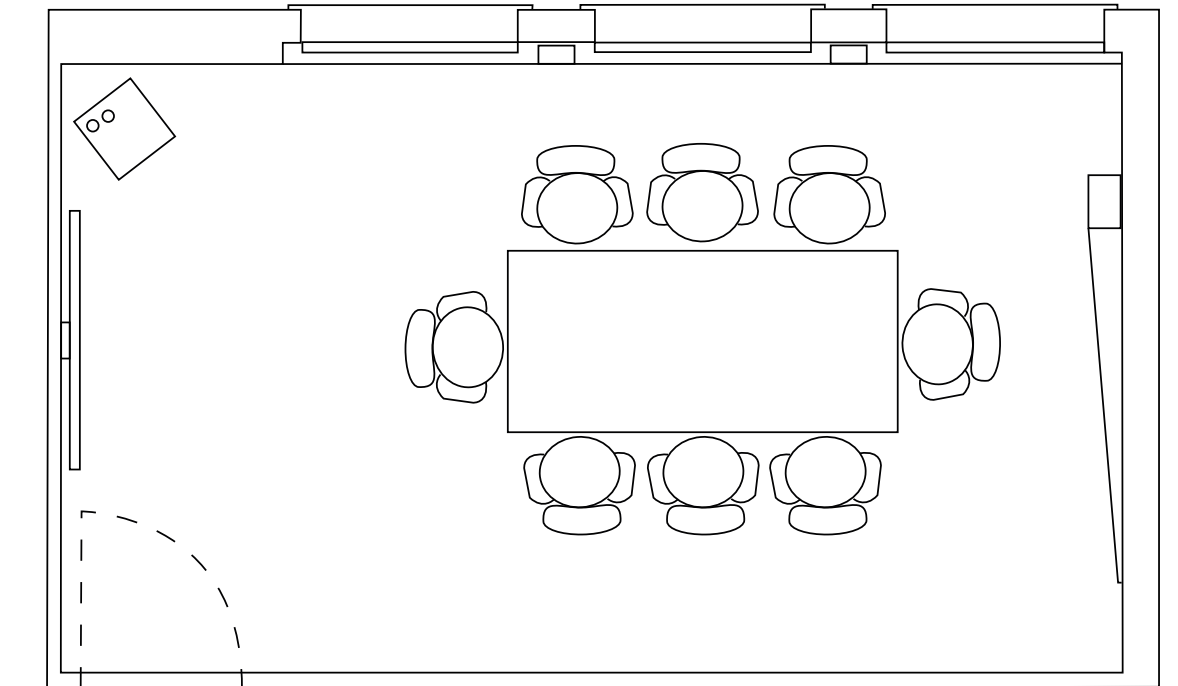

## Capacity & Equipment

- Up to 8 People
- LG Screen 4K, LED, 2022, 65
- Logitech Rally Bar Conference Cam & Speakers
- Whiteboard
- Office Material Trolley
- USB-C Connector
- HDMI - Connection

**Price: from 95 CHF/H**



# Meeting Room | Our Flexible Rooms for 6 - 12 People



Thetys & Calypso

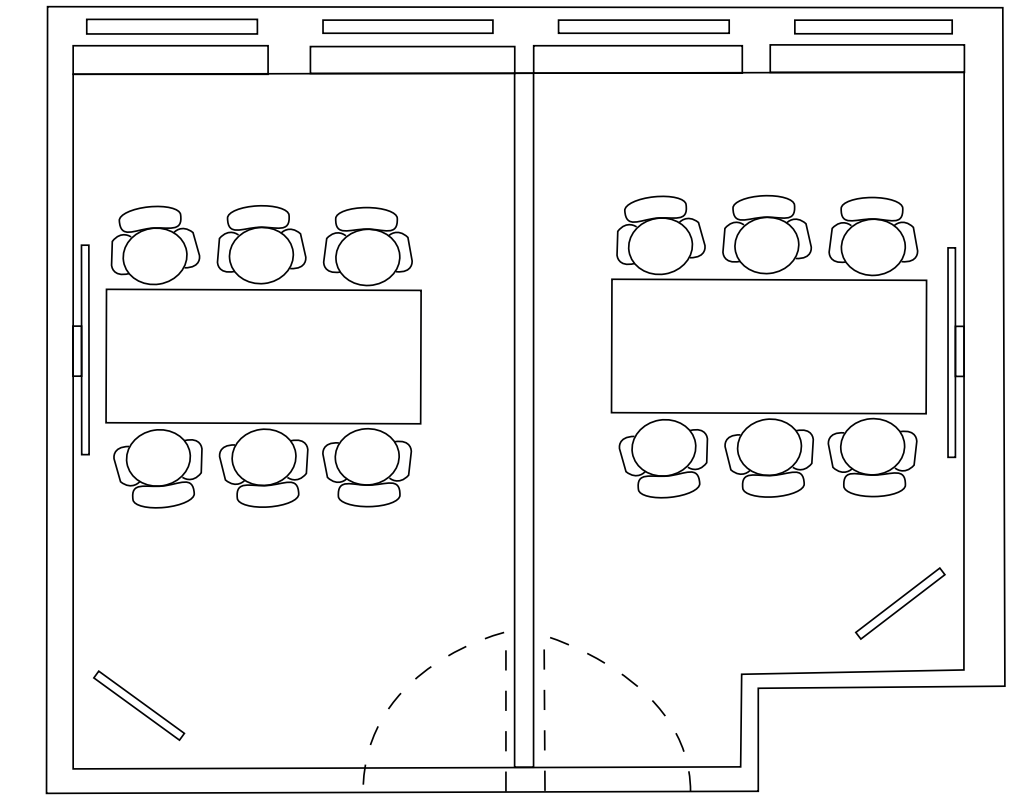

## Capacity & Equipment

- Up to 6 - 12 People when combined
- LG Screen 4K, LED, 2022, 65
- Logitech Rally Bar Conference Cam & Speakers
- Whiteboard
- Office Material Trolley
- USB-C Connector
- HDMI - Connection

The two rooms are separated by a partition wall which can be opened for a larger meeting

**Price: 6 People 90 CHF/H**

**Price: 12 People 130 CHF/H**



# Meeting Room | Our Flexible Room for 10 People



Atlas

## Capacity & Equipment

- Up to 10 People when combined
- LG Screen 4K, LED, 2022, 65
- Logitech Rally Bar Conference Cam & Speakers
- Whiteboard
- Office Material Trolley
- USB-C Connector
- HDMI - Connection

**Price: 120 CHF/H**



# Meeting Room | Our Room for 12 People



Sinope

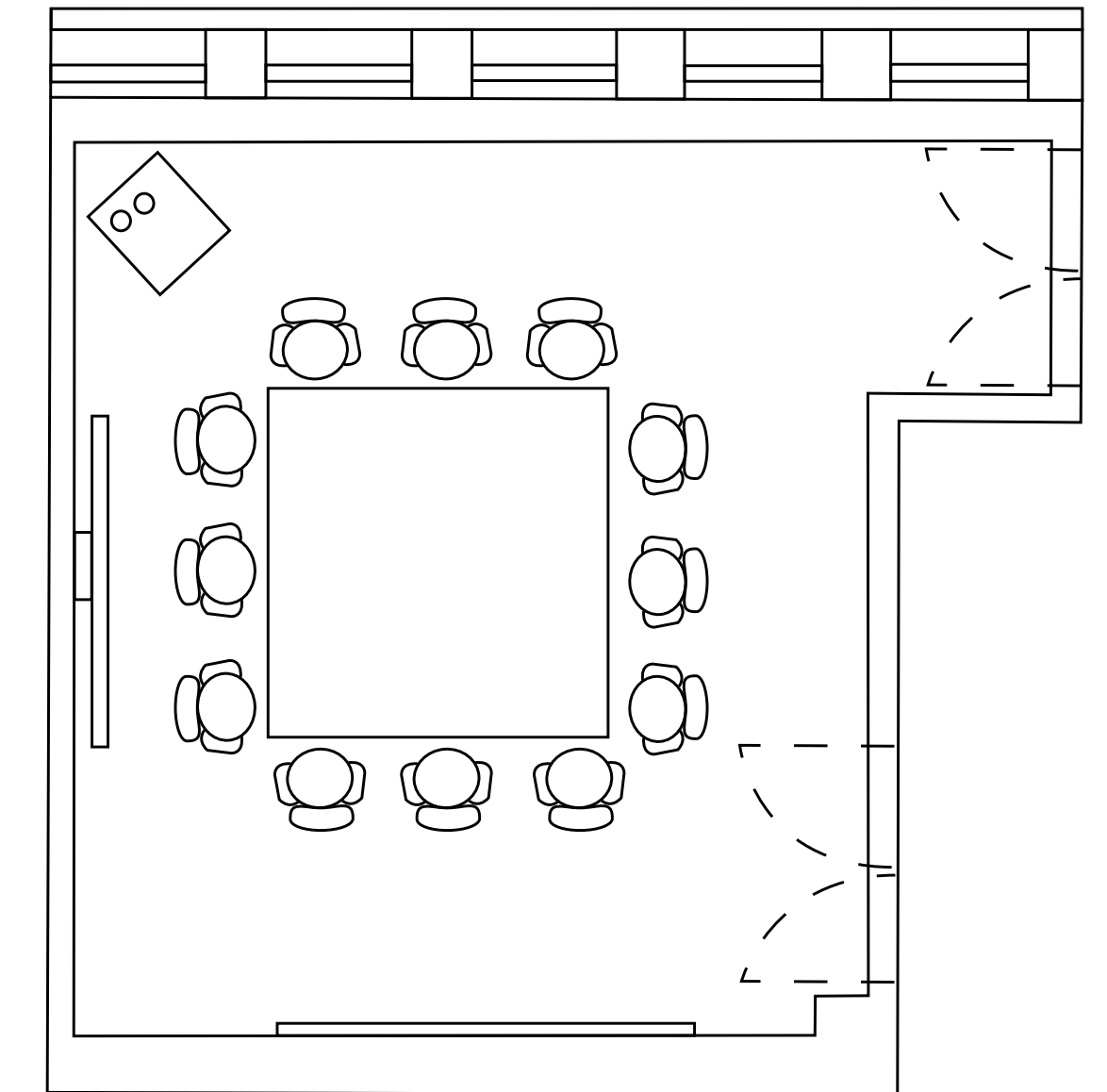

## Capacity & Equipment

- Up to 12 People
- LG Screen 4K, LED, 2022, 65
- Logitech Rally Bar Conference Cam & Speakers
- Whiteboard
- Office Material Trolley
- USB-C Connector
- HDMI - Connection

**Price: 120 CHF/H**



# Meeting Room | Our Room for 20 People

Himalia



## Capacity & Equipment

- Up to 20 people
- LG Screen 4K, LED, 2022, 65
- Logitech Rally Bar Conference Cam & Speakers
- Whiteboard
- Office Material Trolley
- USB-C Connector
- HDMI - Connection

**Price: 140 CHF/H**



# Event Room | Our Event and Workshop Room for 60 People



Kallisto/Europa

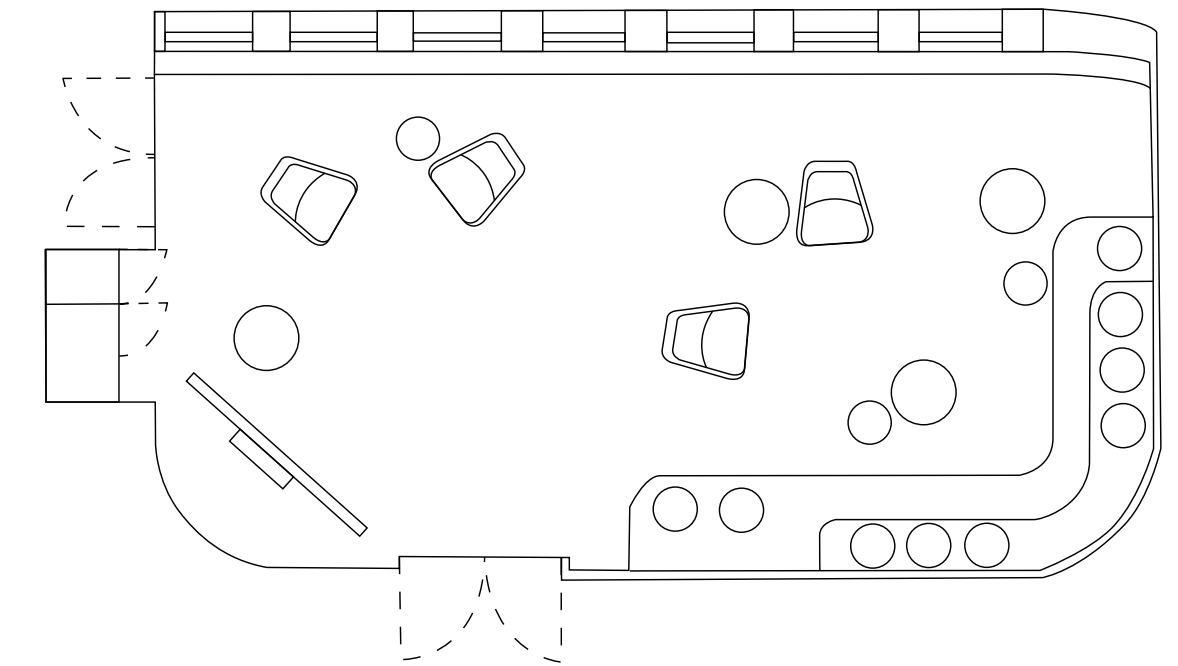

## Capacity & Equipment

- Up to 30 - 60 People
- Portable LG Screen 4K, LED, 2022, 65
- Logitech Rally Bar Conference Cam & Speakers
- Whiteboard
- Office Material Trolley
- USB-C Connector
- HDMI - Connection
- Stackable conference chairs
- Conference table on request

**Price: 180 CHF/H**



# Event Room | Our Event Room for 40 People



Pixel

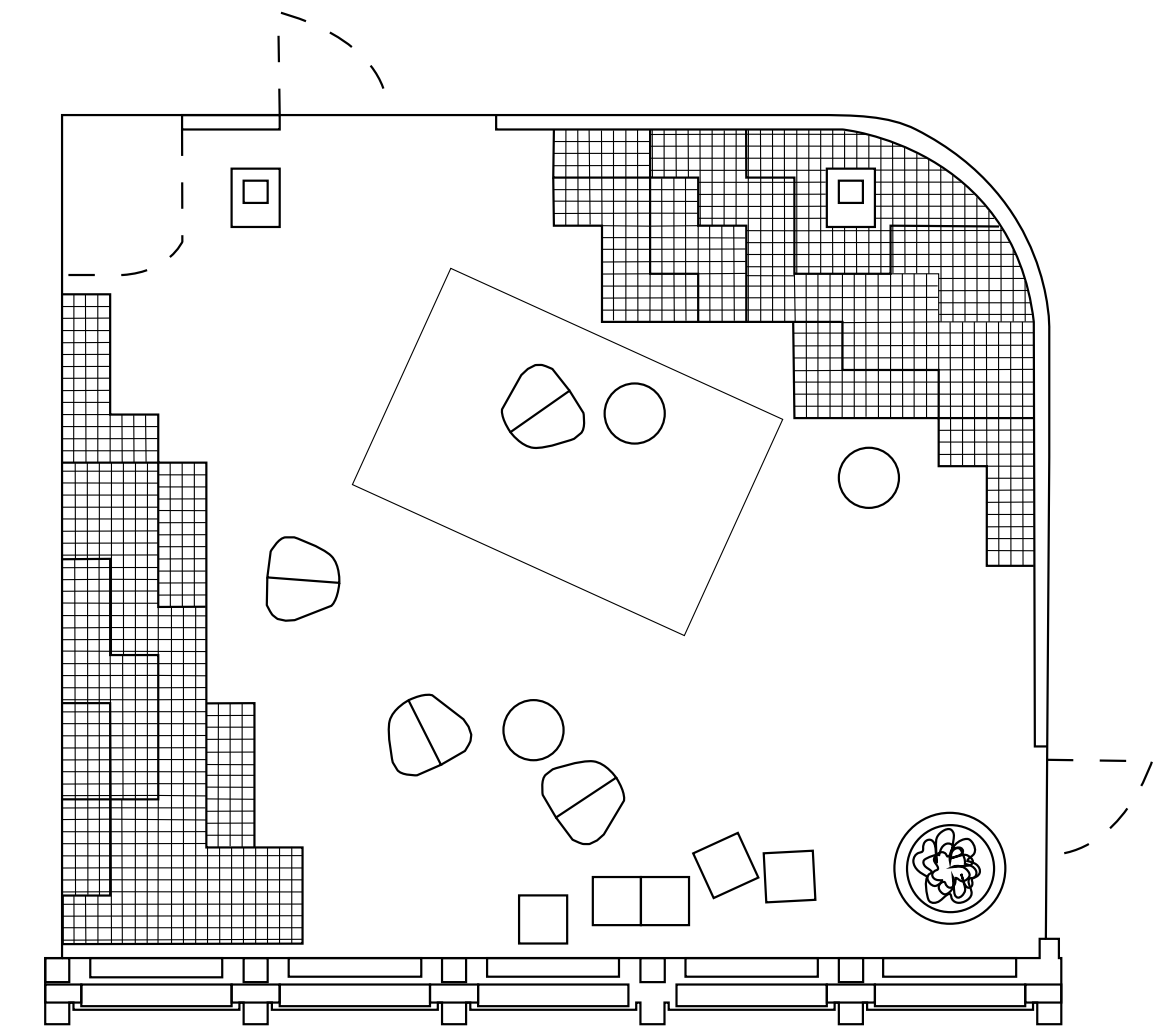

## Capacity & Equipment

- Up to 30 - 40 People, depending on the setting
- Boardstyle: 40 pax. / Theat: 30 pax. / Workshop 10 pax.
- Portable LG Screen 4K, LED, 2022, 65
- Logitech Rally Bar Conference Cam & Speakers
- Whiteboard
- Office Material Trolley
- USB-C Connector
- HDMI - Connection
- Stackable conference chairs
- Conference table on request

**Price: 170 CHF/H**





# Community

The international atmosphere is a central component of the HeadsQuarter concept. At our regular and exclusive community events, we overcome language and cultural barriers - in English, Swiss German, French or Spanish: this is where ideas are exchanged, creative approaches are inspired and new perspectives are discovered.

With the experience of 200+ events, we optimized our offering to make your event a success.



Headsquarter opening 2024



Headsquarter CEO

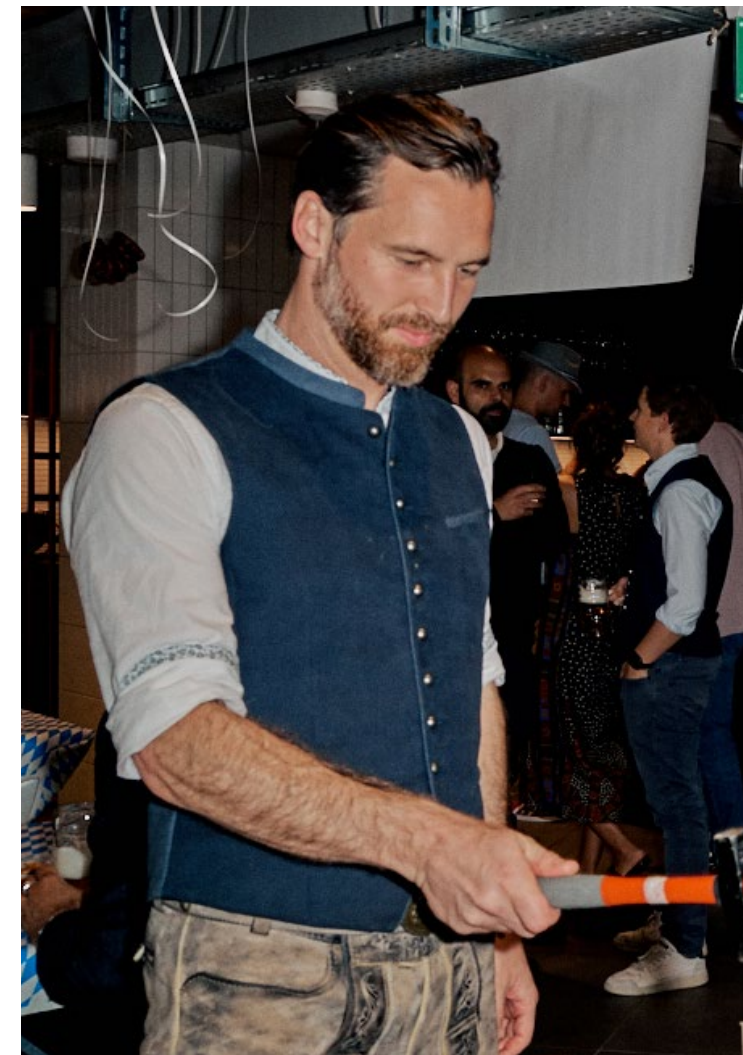
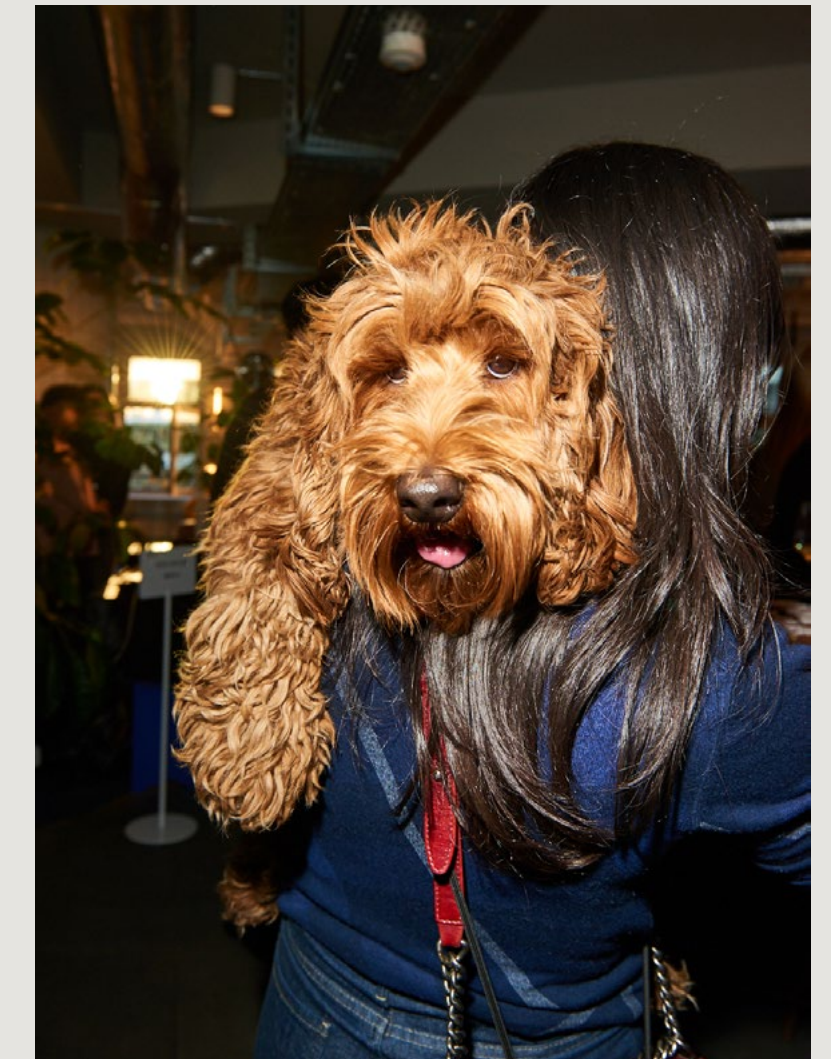

Oktoberfest



V day Brunch



Smith & Smith



# Rates

## Meeting Rooms for 4 - 12 People

Helike _____	4 pax.	CHF. 80/h
Metis _____	6 pax.	CHF. 90/h
Amalthea _____	6 pax.	CHF. 90/h
Kore _____	6 pax.	CHF. 90/h
Cyllene _____	6 pax.	CHF. 90/h
Elara _____	6 pax.	CHF. 90/h
Sinope _____	12 pax.	CHF. 120/h

## Event Room for up to 60 People

Kallisto/Europa ___	30 - 60 pax.	CHF. 180/h
---------------------	--------------	------------

## Event Rooms to combine

Calypso & Thetys _____	CHF. 130/h
Kallisto & Sinope _____	CHF. 300/h
Recording Studio _____	CHF. 110/h
On - site IT Support _____	CHF. 150/h

## Meeting Rooms for 6 - 20 People

Daphnis _____	6 pax.	CHF. 90/h
Thetys _____	6 pax.	CHF. 90/h
Calypso _____	6 pax.	CHF. 90/h
Rhea _____	9 pax.	CHF. 95/h
Dione _____	8 pax.	CHF. 95/h
Atlas _____	10 pax.	CHF. 120/h
Himalia _____	20 pax.	CHF. 140/h
Leda _____	8 - 10 pax.	CHF. 110/h

## Event Room for up to 30 - 40 People

Pixxel _____	35 pax.	CHF. 170/h
--------------	---------	------------

## Equipment

2x Yamaha speakers _____	CHF. 85/h
1x Wireless Mic incl. mixer _____	CHF. 50/h
2x Rode Wireless go _____	CHF. 40/h
2x Rode Wireless Lavalier _____	CHF. 30/h
1x Meeting OWL 360 c _____	CHF. 25/h
1x Workshop case _____	Free

**Our offering includes a big pad with an integrated video camera, individually composable cubes, a Flipchart, HDMI and USB-C connectors, and writing material.**

Host - Support \_\_\_\_\_ CHF. 55.00 / h  
Organization fee \_\_\_ 10% from total amount

The rates include high-quality coffee, tea, water, and snacks from our community kitchen.

All prices are in CHF and exclude VAT.

\*For a full day we charge 8 hours



# Room Settings

## Boardroom

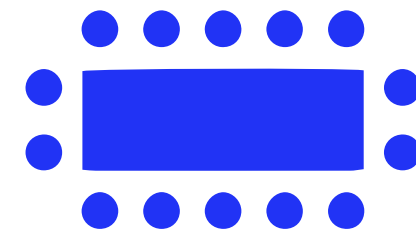

Rectangular tables with all-round seating.  
**Suitable for** Metis, Amalthea, Sinope Cyllene, Elara, Calypso, Thetys, Dione, Kallisto, Atlas & Kore.

## Herringbone seating chevronstyle

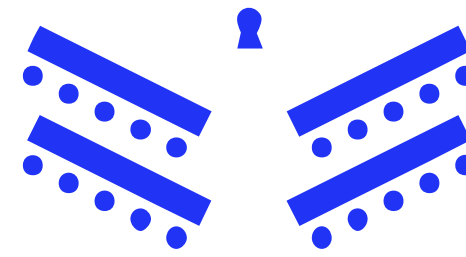

Special form of block seating; oval table without corners, seating all around.  
**Suitable for** Pixxel.

## Banquet

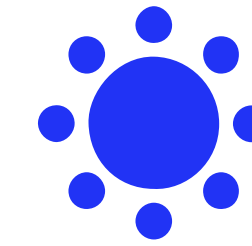

(Mostly) round tables with usually 6-12 chairs per table, seating all around.  
**Suitable for** Himalia, Leda, Europa.

## Cabaret

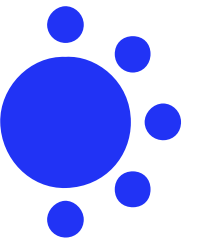

Similar to banquet seating, but open towards the stage, with no seating in that direction.  
**Suitable for** Himalia, Leda, Europa.

## Varieties

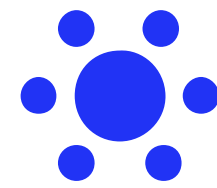

Similar to banquet seating, but with a smaller table and only 4-6 chairs.  
**Suitable for** Himalia, Leda, Europa.

## Square

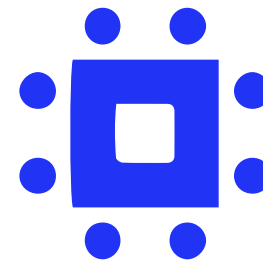

Celebration tables are arranged in a way that leaves an open area in the center.  
**Suitable for** Kallisto, Pixxel, Europa.

## U-Form

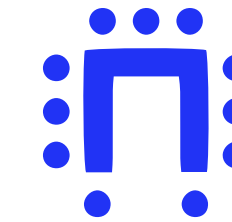

U-shaped tables with seating on one or both sides.  
**Suitable for** Kallisto, Pixxel, Europa.

## E-Form

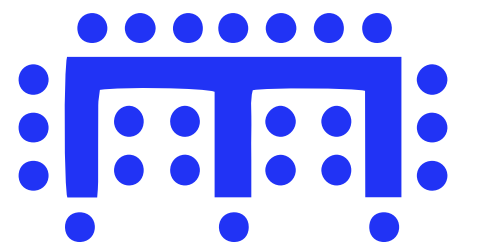

E-shaped tables with seating on one or both sides.  
**Suitable for** Pixxel, Europa.

## Theatre seating

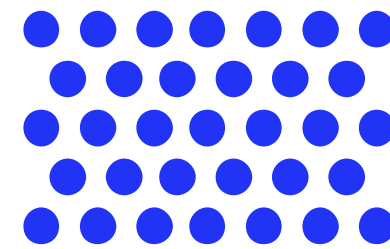

Rows of staggered chairs facing the same direction, without tables.  
**Suitable for** Kallisto, Pixxel, Europa.

## Row seating

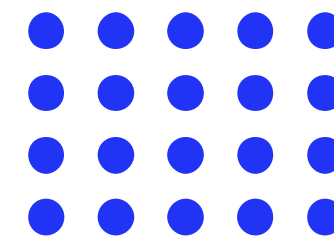

Rows of chairs placed one behind the other, without tables.  
**Suitable for** Kallisto, Pixxel, Europa.

## Parliamentary seating

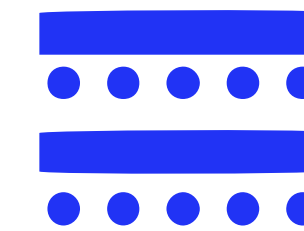

Similar to row seating, but with tables.  
**Suitable for** Kallisto, Pixxel, Europa.



# Catering

**To complete your event we offer various culinary options.**

Be it a delicious morning buffet or a well-planned aperitif with service staff. Our offer is diverse and we cooperate with selected high-quality catering companies.

**Breakfast light** \_\_\_\_\_ **CHF 11.50 / p.P**

Croissants, fresh fruits. Orangejuice.

**Brunch buffet** \_\_\_\_\_ **CHF 24.50 / p.P**

Croissants, bread, marmelade, butter, fruits, Orangejuice, cheese platter & muesli.

**Lunch** \_\_\_\_\_ **from CHF 20 / p.P**

We work with several caterers - let us know what you are looking for.

**Apéro light** \_\_\_\_\_ **CHF 26.50 / p.P**

Apéro platters with cold meats and cheese, vegetables, houmous, fresh dips and bread.

**Apéro riche** \_\_\_\_\_ **CHF 34.50 / p.P**

Warm & cold apéro platters with cold meats and cheese, vegetables, house made houmous, fresh dips and bread. Sweets.

## Our Wine Collection & Beer Keller

Sauvignon Blanc «Rufus» AOC \_\_\_\_\_ CHF. 56.00

Zürich Herter Wein \_\_\_\_\_ CHF. 56.00

Gulfi «Nero Baronj 2018» \_\_\_\_\_ CHF. 61.00

Prosecco Extra Dry «Nudo» \_\_\_\_\_ CHF. 48.00

DOC Veneto Colli del Soli \_\_\_\_\_ CHF. 48.00

Beer Cellar à discrétion \_\_\_\_\_ CHF. 8 / p.P



Host - Support \_\_\_\_\_ CHF. 55.00 / h  
Organization fee \_\_ 10% from total amount

The rates include high-quality coffee, tea, water, and snacks from our community kitchen.

All prices are in CHF and exclude VAT.



# Lunch Guide

**Looking for a lunch spot?  
Just ask our hosts for individual recommendations.**

Riithalle

George bar & Grill

El Lokal

Löweneck

Astra kitchen and bar

Joe and the juice

Moser

Glockenhof

Cafe Handelshof

Hiltl

Tales bar

Kraftwerk

Rimini bar

Certo

Arctic juice

Kasa Kaisin

Cartell

Baradox

The BAB

Kaimug

Viet streetfood

Tiny fish

Takano city

Sushi shop

Babus

Zapote

Long Huang

Kraftwerk

**Our absolute insider over lunch - [Talacker restaurant and bar](#)**





# Coming soon.

**Stockerstrasse 33**  
8002 Zürich

- 4100m<sup>2</sup>
- 550+ work tables
- Office space from 2 - 20 people
- Five floors
- Large event room
- Rooftop bar
- Recording Studio

Event and Meeting Room Space.



**Get in touch  
with us.**

**+ 41 44 520 62 62**

**events@headquarter.com**

